

REV.	DESCRIPTION	DATE
A	RELEASE	Dec. 24, 2009
B	ADD. PACKAGE	Dec. 20, 2017
C	CHANGE CODE	Jan. 16, 2018

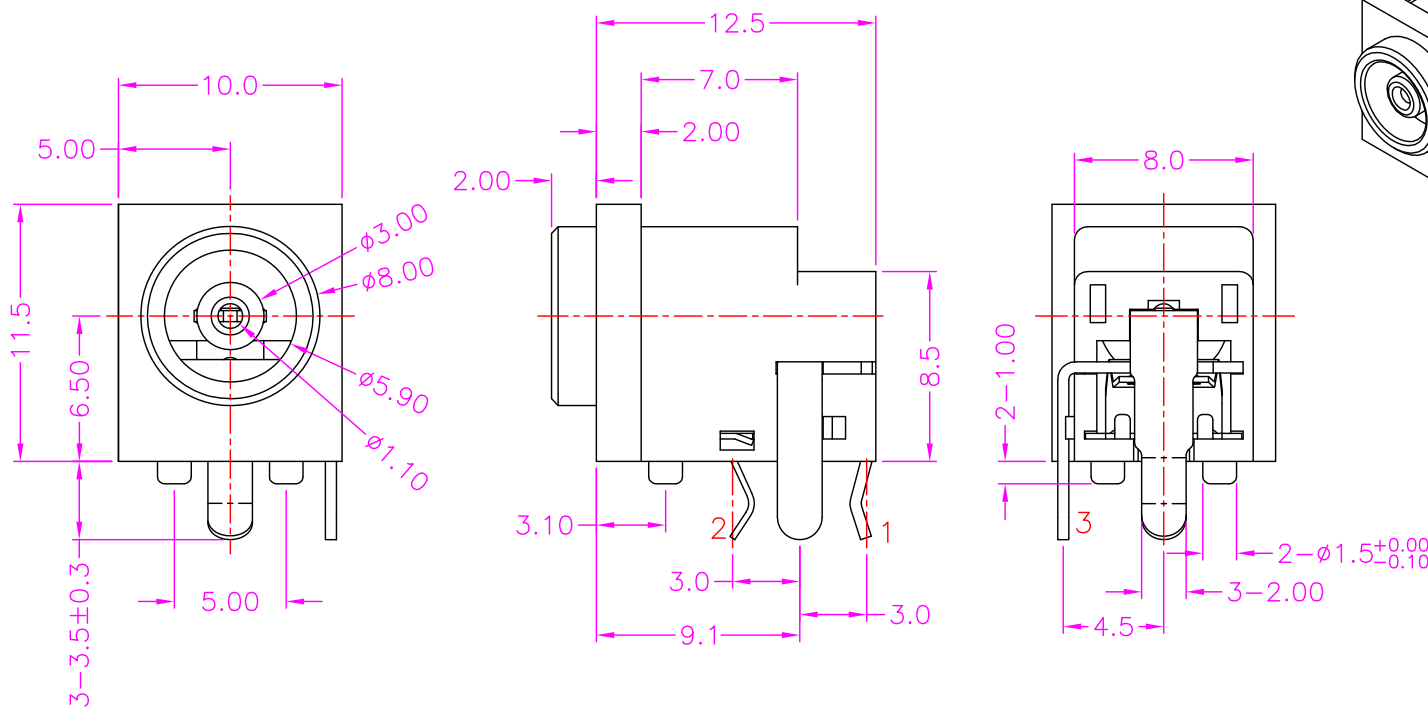
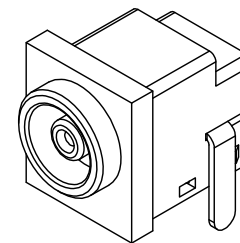

MATERIALS

1. HOUSING : P.B.T (UL 94V-0), BLACK.
2. TERMINAL : TIN PLATING.
1&3 PIN, BRASS.
2 PIN, PHOSPHOR BRONZE.

SPECIFICATION

1. CURRENT RATING : 3A MAX.
2. DIELECTRIC WITHSTANDING VOLTAGE :
500V AC R.M.S. FOR ONE MINUTE.
3. INSULATION RESISTANCE : 100M OHMS MIN.
AT 500V DC
4. CONTACT RESISTANCE : 50m OHMS MAX.
5. OPERATING TEMPERATURE : -25°C TO +85°C.
6. DURABILITY : 5000 CYCLES.
7. MATING FORCE : 0.3 ~ 3.0kgs.
8. UNMATING FORCE : 0.3 ~ 3.0kgs.

PART NUMBER INFORMATION

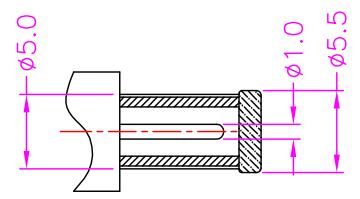
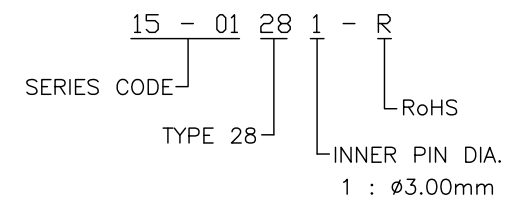

DC MATE PLUG

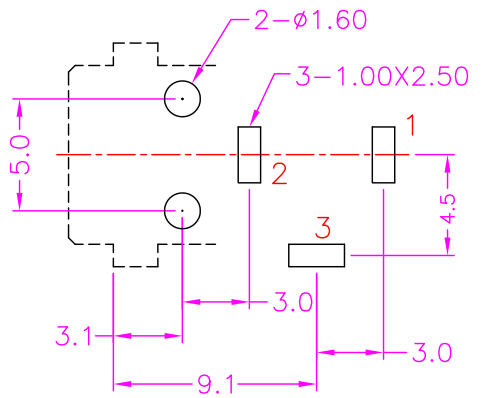

RECOMMEND P.C.B LAYOUT TOP VIEW

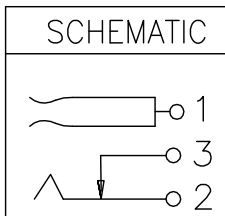

TOLERANCE		DRAWER		NAME
.0=±0.20	.00=±0.10	NFE028		
.000=±.XXX	.0000=±.	CHECK		
ANG.=±3°		APP'D		DRAW NO.
		SRFB		
UNITS : mm		PRODUCT SPEC.		C15-01281-R
SCALE NONE		T-1154		
SIZE A4	SHEET 1 OF 1	REV. C	08026	



REV.	DESCRIPTION	DATE
A	RELEASE	Dec. 24, 2009
B	ADD. PACKAGE	Dec. 20, 2017
C	CHANGE CODE	Jan. 16, 2018

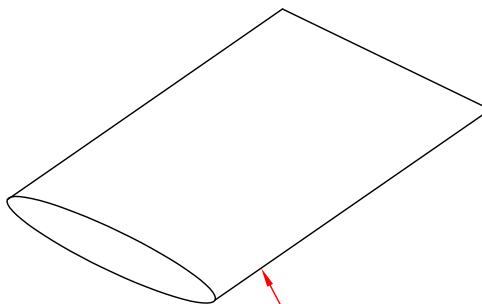
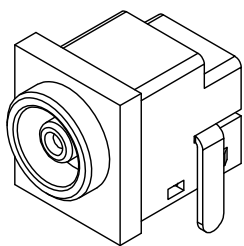

PE BAG

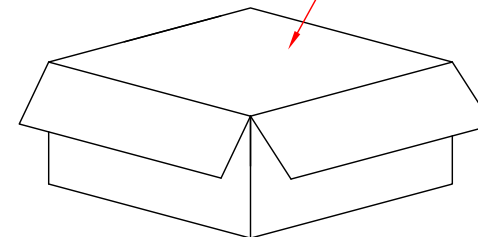
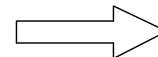

INNER BOX

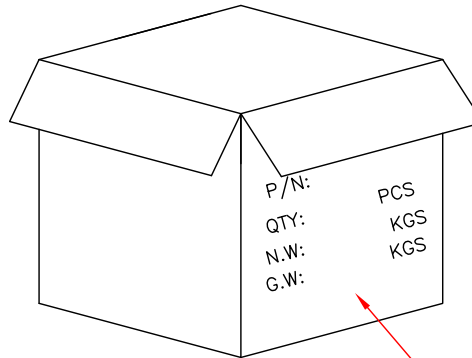
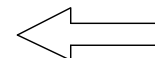
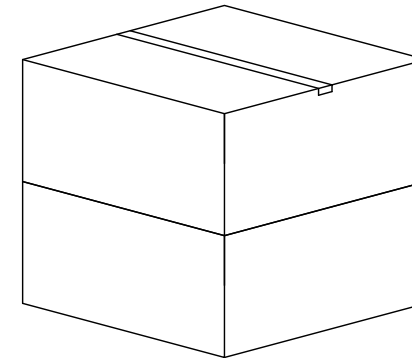

CARTON

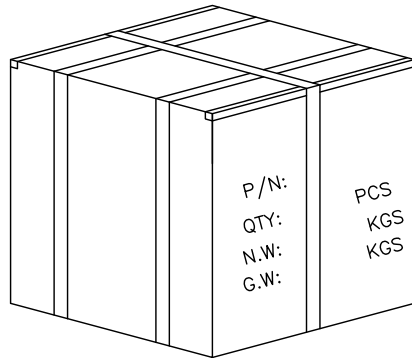
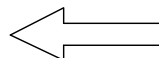

PACKAGE :

QUANTITY:

- 1. 500 PCS/PE BAG
- 2. 8 PE BAG/INNER BOX
- 3. 2 INNER BOX/CARTON

SCHEMATIC

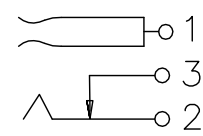

TOLERANCE		DRAWER		Astron WWW.ASTRON.COM.TW
.0=±0.20		NFB028		
.00=±0.10		CHECK		NAME DC POWER JACK P.C.B. MOUNT, FEMALE
.000=±.XXX		JNY		
.0000=±.		APP'D		DRAW NO. C15-01281-R
ANG.=±3°		SRFB		
UNITS : mm		PRODUCT SPEC.		08026
SCALE NONE		T-1154		
SIZE A4		SHEET		REV. C
SHEET 2 OF 2		REV. C		