

REV.	DESCRIPTION	DATE
1	PROPOSAL	Jun. 27, 2017
2	DRAW. MODIFY	Jun. 29, 2017
3	DRAW. MODIFY	Jun. 30, 2017
4	ADD. P/N	Jul. 21, 2017
5	DRAW. MODIFY	Jul. 25, 2018

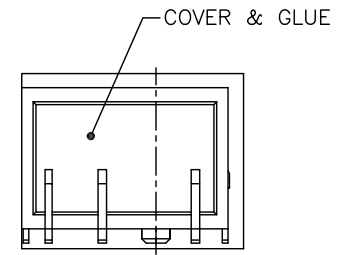
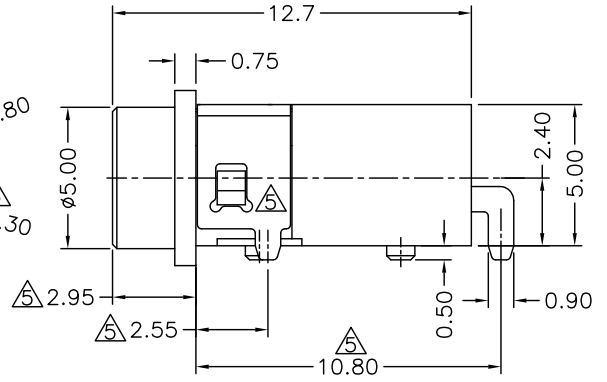
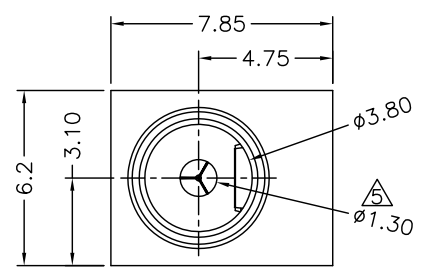

**MATERIALS**

- HOUSING & COVER : NYLON 10T (UL 94V-0), BLACK.
  - TERMINAL : GOLD FLASH PLATING.  
    - PIN1,2 : PHOSPHOR BRONZE
    - PIN3 : BRASS
  - SHIELD : BRASS, NICKEL PLATING.
  - O-RING : Silicone(UL 94V-0)
- Note :  
 (1) Housings and O-rings are packed separately.  
 (2) The O-Ring can not go through the IR process with waterproof connector together.

**SPECIFICATION**

- CURRENT RATING : 2 AMP.
- RATING VOLTAGE : 24V DC
- DIELECTRIC WITHSTANDING VOLTAGE : 500V AC FOR ONE MINUTE.
- INSULATION RESISTANCE : 100M OHMS MIN. AT 500V DC.
- CONTACT RESISTANCE : 50m OHMS MAX.
- INSERTION FORCE : 0.3~3.0kgf
- EXTRACTION FORCE : 0.3~3.0kgf
- DURABILITY : 5000 CYCLES.
- OPERATING TEMPERATURE : -25°C TO +70°C.
- WATERPROOF LEVEL : IP-X7 (30min/1M)

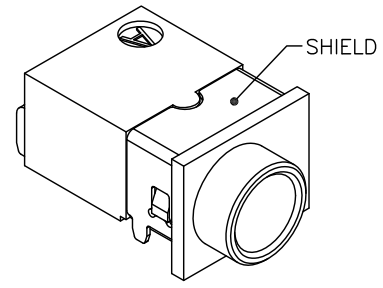
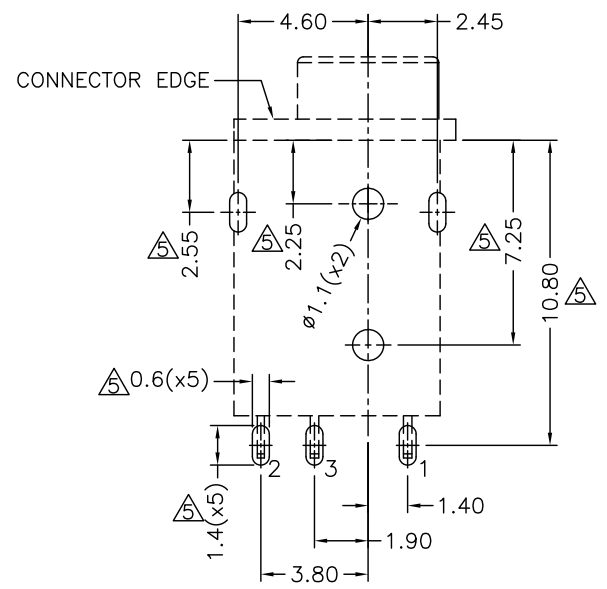
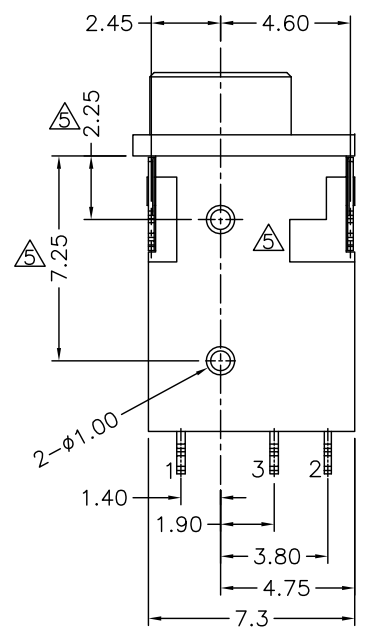

**PART NUMBER INFORMATION**

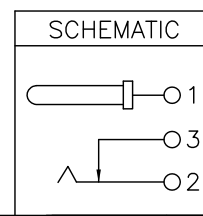
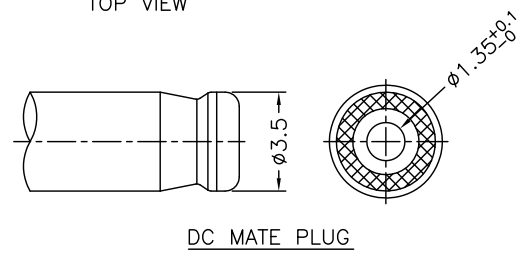
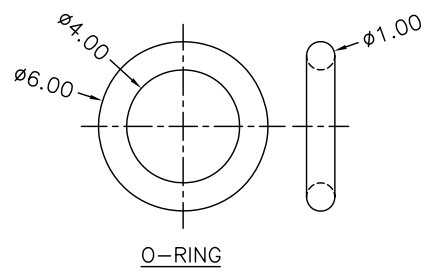
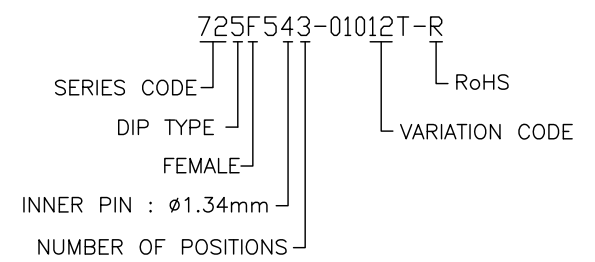

TOLERANCE
.0=±0.30
.00=±0.25
.000=±.XXX
.0000=±.
ANG.=±3°

DRAWER	JINJ
CHECK	NFOLE
APP'D	ERFB
PRODUCT SPEC.	T-1534
SCALE	NONE
SIZE	A4
SHEET	1 OF 1
REV.	5

<b>Astron</b> WWW.ASTRON.COM.TW	
NAME DC POWER JACK DIP, FEMALE, WATERPROOF	
DRAW NO. 725F543-01012T-R	
08026	